

VS 2

Spannschuhunterteil auf Klebplatte C3

Tensioning shoe bottom on sticky pad

Dolna część buta zaciskowego do klejenia

Башмачок-крепление, нижняя часть для приклеивания



max.
2 m²

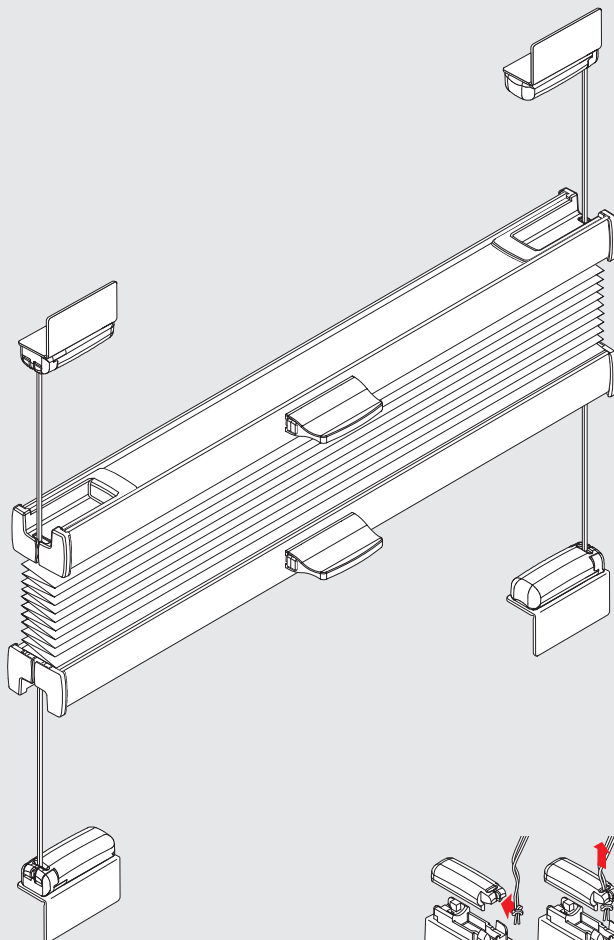

Wichtig! Bitte mit der Pflegeanleitung aufbewahren! • Important! Please keep together with care instructions!
Ważne! Proszę przechowywać z instrukcją pielęgnacji! • Внимание! Хранить вместе с инструкцией по эксплуатации!

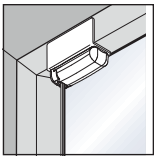

Falzmontage
Top fixing
Montaż w świetle szyby
Монтаж в проем

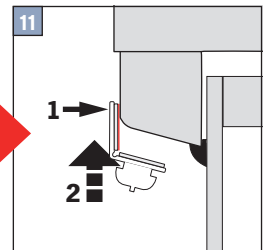
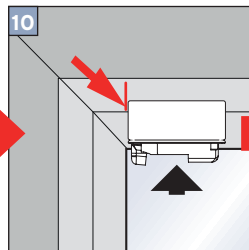
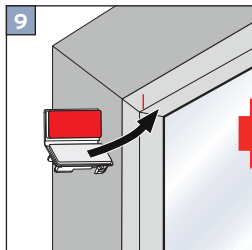
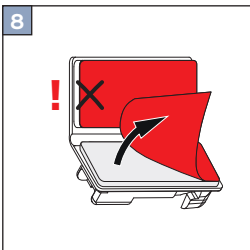
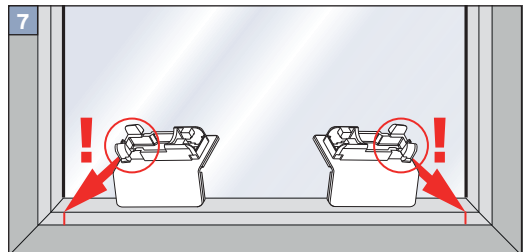
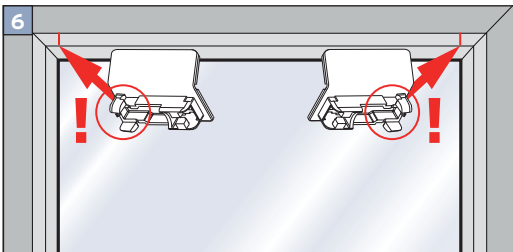
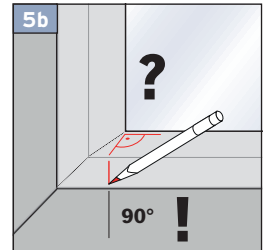
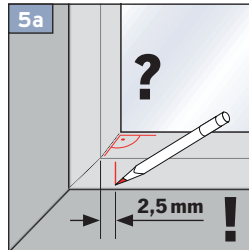
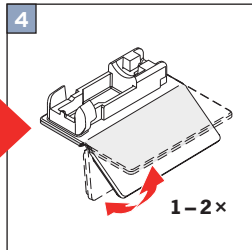
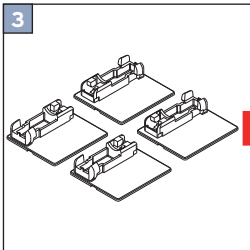
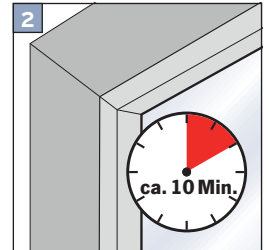
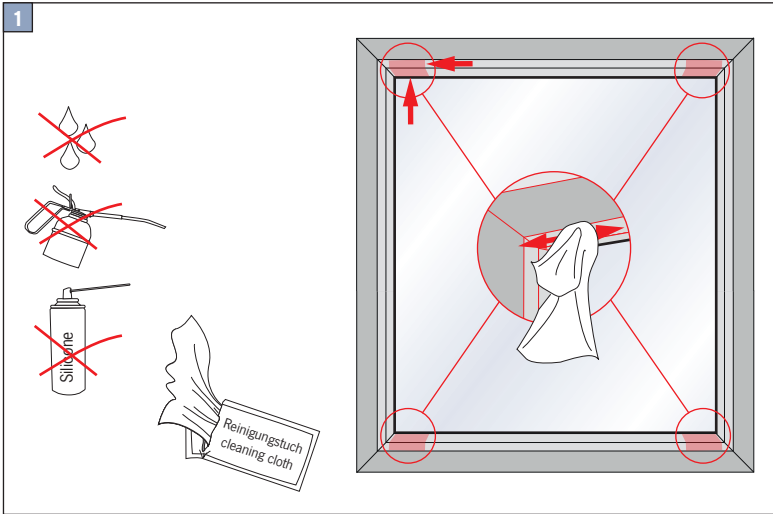

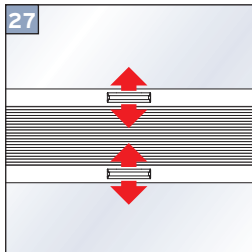
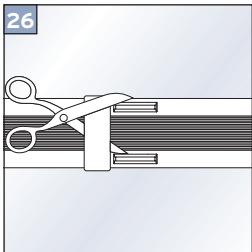
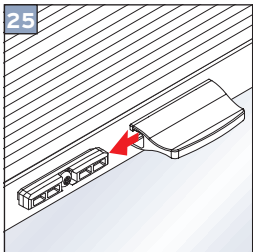
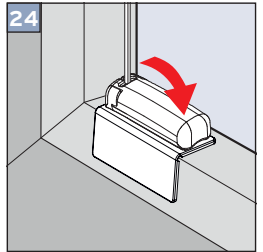
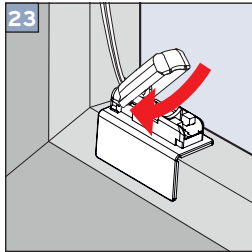
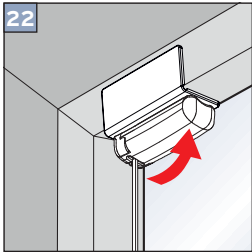
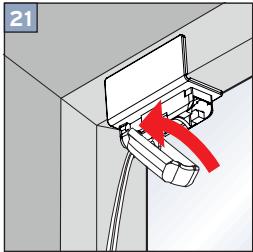
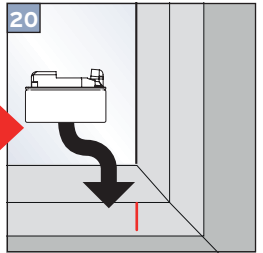
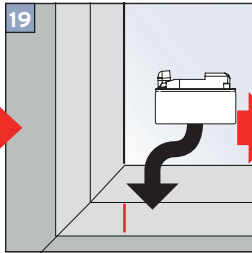
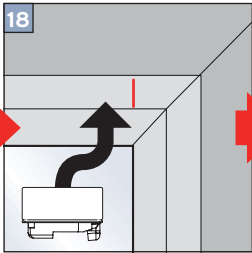
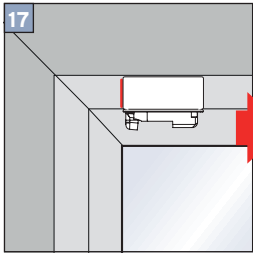
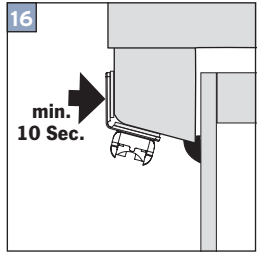
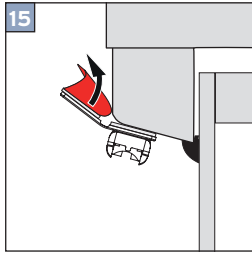
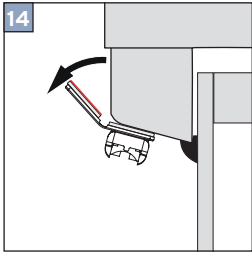
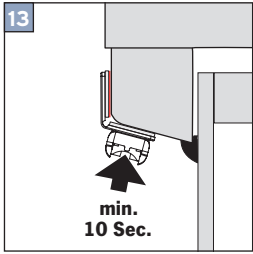

Demontage • Disassembly • Demontaž • Демонтаж

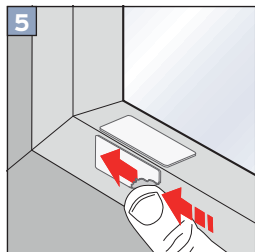
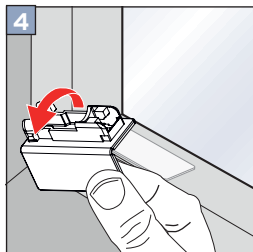
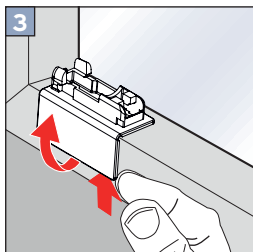
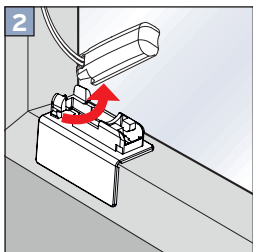
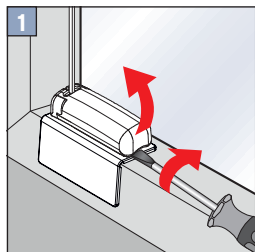

Option • Опција • Вариант

